

# Quadrature Signals: Complex, But Not Complicated

by Richard Lyons

## Introduction

Quadrature signals are based on the notion of complex numbers and perhaps no other topic causes more heartache for newcomers to DSP than these numbers and their strange terminology of *j-operator*, *complex*, *imaginary*, *real*, and *orthogonal*. If you're a little unsure of the physical meaning of complex numbers and the  $j = \sqrt{-1}$  operator, don't feel bad because you're in good company. Why even Karl Gauss, one of the world's greatest mathematicians, called the *j-operator* the "shadow of shadows". Here we'll shine some light on that shadow so you'll never have to call the Quadrature Psychic Hotline for help.

Quadrature signal processing is used in many fields of science and engineering, and quadrature signals are necessary to describe the processing and implementation that takes place in modern digital communications systems. In this tutorial we'll review the fundamentals of complex numbers and get comfortable with how they're used to represent quadrature signals. Next we examine the notion of negative frequency as it relates to quadrature signal algebraic notation, and learn to speak the language of quadrature processing. In addition, we'll use three-dimensional time and frequency-domain plots to give some physical meaning to quadrature signals. This tutorial concludes with a brief look at how a quadrature signal can be generated by means of *quadrature-sampling*.

## Why Care About Quadrature Signals?

Quadrature signal formats, also called *complex* signals, are used in many digital signal processing applications such as:

- digital communications systems,
- radar systems,
- time difference of arrival processing in radio direction finding schemes
- coherent pulse measurement systems,
- antenna beamforming applications,
- single sideband modulators,
- etc.

These applications fall in the general category known as *quadrature processing*, and they provide additional processing power through the coherent measurement of the phase of sinusoidal signals.

A quadrature signal is a two-dimensional signal whose value at some instant in time can be specified by a single *complex number* having two parts; what we call the *real* part and the *imaginary* part. (The words real and imaginary, although traditional, are unfortunate because of their meanings in our every day speech. Communications engineers use the terms *in-phase* and *quadrature* phase. More on that later.) Let's review the mathematical notation of these complex numbers.

## The Development and Notation of Complex Numbers

To establish our terminology, we define a *real* number to be those numbers we use in every day life, like a voltage, a temperature on the Fahrenheit scale, or the balance of your checking account. These one-dimensional numbers can be either positive or negative as depicted in Figure 1(a). In that figure we show a one-dimensional axis and say that a single real number can be represented by a point on that axis. Out of tradition, let's call this axis, the Real axis.

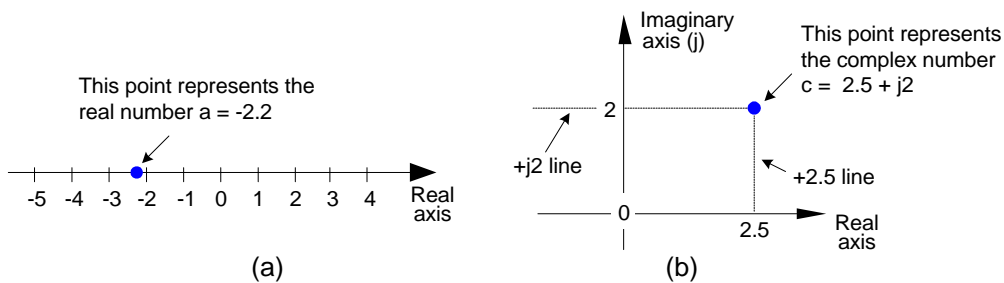

**Figure 1.** An graphical interpretation of a real number and a complex number.

A complex number,  $c$ , is shown in Figure 1(b) where it's also represented as a point. However, complex numbers are not restricted to lie on a one-dimensional line, but can reside anywhere on a two-dimensional plane. That plane is called the *complex plane* (some mathematicians like to call it an *Argand diagram*), and it enables us to represent complex numbers having both real and imaginary parts. For example in Figure 1(b), the complex number  $c = 2.5 + j2$  is a point lying on the complex plane on neither the real nor the imaginary axis. We locate point  $c$  by going +2.5 units along the real axis and up +2 units along the imaginary axis. Think of those real and imaginary axes exactly as you think of the East-West and North-South directions on a road map.

We'll use a geometric viewpoint to help us understand some of the arithmetic of complex numbers. Taking a look at Figure 2, we can use the trigonometry of right triangles to define several different ways of representing the complex number  $c$ .

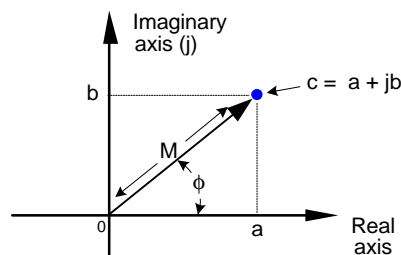

**Figure 2** The phasor representation of complex number  $c = a + jb$  on the complex plane.

Our complex number  $c$  is represented in a number of different ways in the literature, such as:

Notation Name:	Math Expression:	Remarks:	
Rectangular form:	$c = a + jb$	Used for explanatory purposes. Easiest to understand. [Also called the <i>Cartisian</i> form.]	(1)
Trigonometric form:	$c = M[\cos(\phi) + j\sin(\phi)]$	Commonly used to describe quadrature signals in communications systems.	(2)
Polar form:	$c = Me^{j\phi}$	Most puzzling, but the primary form used in math equations. [Also called the <i>Exponential</i> form. Sometimes written as $M\exp(j\phi)$ .]	(3)
Magnitude-angle form:	$c = M\angle\phi$	Used for descriptive purposes, but too cumbersome for use in algebraic equations. [Essentially a shorthand version of Eq. (3).]	(4)

Eqs. (3) and (4) remind us that  $c$  can also be considered the tip of a phasor on the complex plane, with magnitude  $M$ , in the direction of  $\phi$  degrees relative to the positive real axis as shown in Figure 2. Keep in mind that  $c$  is a complex number and the variables  $a$ ,  $b$ ,  $M$ , and  $\phi$  are all real numbers. The magnitude of  $c$ , sometimes called the *modulus* of  $c$ , is

$$M = |c| = \sqrt{a^2 + b^2} \quad (5)$$

[Trivia question: In what 1939 movie, considered by many to be the greatest movie ever made, did a main character attempt to quote Eq. (5)?]

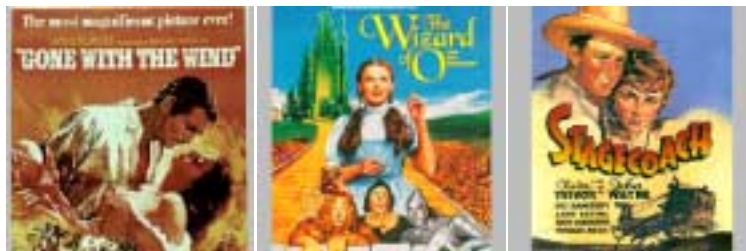

Back to business. The phase angle  $\phi$ , or *argument*, is the arctangent of the ratio  $\frac{\text{imaginary part}}{\text{real part}}$ , or

$$\phi = \tan^{-1} \left( \frac{b}{a} \right) \quad (6)$$

If we set Eq. (3) equal to Eq. (2),  $Me^{j\phi} = M[\cos(\phi) + j\sin(\phi)]$ , we can state what's named in his honor and now called one of *Euler's identities* as:

$$e^{j\phi} = \cos(\phi) + j\sin(\phi) \quad (7)$$

The suspicious reader should now be asking, "Why is it valid to represent a complex number using that strange expression of the base of the natural logarithms, e, raised to an imaginary power?" We can validate Eq. (7) as did the world's greatest expert on infinite series, Herr Leonard Euler, by plugging  $j\phi$  in for  $z$  in the series expansion definition of  $e^z$  in the top line of Figure 3. That substitution is shown on the second line. Next we evaluate the higher orders of  $j$  to arrive at the series in the third line in the figure. Those of you with elevated math skills like Euler (or those who check some math reference book) will recognize that the alternating terms in the third line are the series expansion definitions of the cosine and sine functions.

$$\begin{aligned}
 e^z &= 1 + z + \frac{z^2}{2!} + \frac{z^3}{3!} + \frac{z^4}{4!} + \frac{z^5}{5!} + \frac{z^6}{6!} + \dots \\
 e^{j\phi} &= 1 + j\phi + \frac{(j\phi)^2}{2!} + \frac{(j\phi)^3}{3!} + \frac{(j\phi)^4}{4!} + \frac{(j\phi)^5}{5!} + \frac{(j\phi)^6}{6!} + \dots \\
 e^{j\phi} &= 1 + j\phi - \frac{\phi^2}{2!} - j\frac{\phi^3}{3!} + \frac{\phi^4}{4!} + j\frac{\phi^5}{5!} - \frac{\phi^6}{6!} + \dots
 \end{aligned}$$

$$e^{j\phi} = \cos(\phi) + j\sin(\phi)$$

**Figure 3** One derivation of Euler's equation using series expansions for  $e^z$ ,  $\cos(\phi)$ , and  $\sin(\phi)$ .

Figure 3 verifies Eq. (7) and our representation of a complex number using the Eq. (3) polar form:  $Me^{j\phi}$ . If you substitute  $-j\phi$  for  $z$  in the top line of Figure 3, you'd end up with a slightly different, and very useful, form of Euler's identity:

$$e^{-j\phi} = \cos(\phi) - j\sin(\phi) \quad (8)$$

The polar form of Eqs. (7) and (8) benefits us because:

- It simplifies mathematical derivations and analysis,
  - turning trigonometric equations into the simple algebra of exponents, and
  - math operations on complex numbers follow exactly the same rules as real numbers.
- It makes adding signals merely the addition of complex numbers (vector addition),
- It's the most concise notation,
- It's indicative of how digital communications system are implemented, and described in the literature.

We'll be using Eqs. (7) and (8) to see why and how quadrature signals are used in digital communications applications. But first, let's take a deep breath and enter the Twilight Zone of that 'j' operator.

You've seen the definition  $j = \sqrt{-1}$  before. Stated in words, we say that  $j$  represents a number when multiplied by itself results in a negative one. Well, this definition causes difficulty for

the beginner because we all know that any number multiplied by itself always results in a positive number. (Unfortunately DSP textbooks often define  $j$  and then, with justified haste, swiftly carry on with all the ways that the  $j$  operator can be used to analyze sinusoidal signals. Readers soon forget about the question: What does  $j = \sqrt{-1}$  actually mean?) Well,  $\sqrt{-1}$  had been on the mathematical scene for some time, but wasn't taken seriously until it had to be used to solve cubic equations in the sixteenth century. [1], [2] Mathematicians reluctantly began to accept the abstract concept of  $\sqrt{-1}$ , without having to visualize it, because its mathematical properties were consistent with the arithmetic of normal real numbers.

It was Euler's equating complex numbers to real sines and cosines, and Gauss' brilliant introduction of the complex plane, that finally legitimized the notion of  $\sqrt{-1}$  to Europe's mathematicians in the eighteenth century. Euler, going beyond the province of real numbers, showed that complex numbers had a clean consistent relationship to the well-known real trigonometric functions of sines and cosines. As Einstein showed the equivalence of mass and energy, Euler showed the equivalence of real sines and cosines to complex numbers. Just as modern-day physicists don't know what an electron is but they understand its properties, we'll not worry about what 'j' is and be satisfied with understanding its behavior. For our purposes, the  $j$ -operator means rotate a complex number by  $90^\circ$  counterclockwise. (For you good folk in the UK, counterclockwise means anti-clockwise.) Let's see why.

We'll get comfortable with the complex plane representation of imaginary numbers by examining the mathematical properties of the  $j = \sqrt{-1}$  operator as shown in Figure 4.

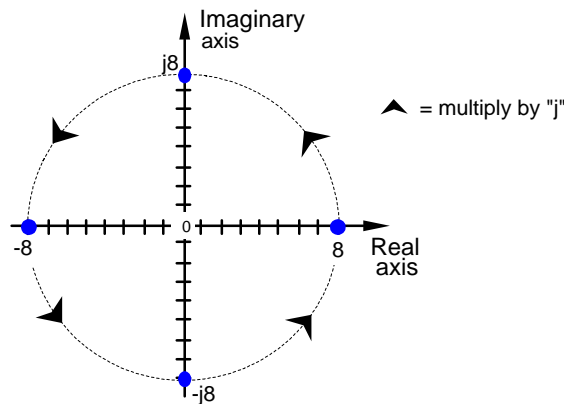

**Figure 4.** What happens to the real number 8 when you start multiplying it by  $j$ .

Multiplying any number on the real axis by  $j$  results in an imaginary product that lies on the imaginary axis. The example in Figure 4 shows that if  $+8$  is represented by the dot lying on the positive real axis, multiplying  $+8$  by  $j$  results in an imaginary number,  $+j8$ , whose position has been rotated  $90^\circ$  counterclockwise (from  $+8$ ) putting it on the positive imaginary axis. Similarly, multiplying  $+j8$  by  $j$  results in another  $90^\circ$  rotation yielding the  $-8$  lying on the negative real axis because  $j^2 = -1$ . Multiplying  $-8$  by  $j$  results in a further  $90^\circ$  rotation giving the  $-j8$  lying on the negative imaginary axis. Whenever any number represented by a dot is multiplied by  $j$  the result is a counterclockwise rotation of  $90^\circ$ . (Conversely, multiplication by  $-j$  results in a clockwise rotation of  $-90^\circ$  on the complex plane.)

If we let  $\phi = \pi/2$  in Eq. 7, we can say that

$$e^{j\pi/2} = \cos(\pi/2) + j\sin(\pi/2) = 0 + j1, \text{ or}$$

$$e^{j\pi/2} = j \tag{9}$$

Here's the point to remember. If you have a single complex number, represented by a point on the complex plane, multiplying that number by  $j$  or by  $e^{j\pi/2}$  will result in a new complex number that's rotated  $90^\circ$  counterclockwise (CCW) on the complex plane. Don't forget this, as it will be useful as you begin reading the literature of quadrature processing systems!

Let's pause for a moment here to catch our breath. Don't worry if the ideas of imaginary numbers and the complex plane seem a little mysterious. It's that way for everyone at first—you'll get comfortable with them the more you use them. (Remember, the  $j$ -operator puzzled Europe's heavyweight mathematicians for hundreds of years.) Granted, not only is the mathematics of complex numbers a bit strange at first, but the terminology is almost bizarre. While the term *imaginary* is an unfortunate one to use, the term *complex* is downright weird. When first encountered, the phrase complex numbers makes us think 'complicated numbers'. This is regrettable because the concept of complex numbers is not really all that complicated. Just know that the purpose of the above mathematical rigmarole was to validate Eqs. (2), (3), (7), and (8). Now, let's (finally!) talk about time-domain signals.

### Representing Real Signals Using Complex Phasors

OK, we now turn our attention to a complex number that is a function time. Consider a number whose magnitude is one, and whose phase angle increases with time. That complex number is the  $e^{j2\pi f_0 t}$  point shown in Figure 5(a). (Here the  $2\pi f_0$  term is frequency in radians/second, and it corresponds to a frequency of  $f_0$  cycles/second where  $f_0$  is measured in Hertz.) As time  $t$  gets larger, the complex number's phase angle increases and our number orbits the origin of the complex plane in a CCW direction. Figure 5(a) shows the number, represented by the black dot, frozen at some arbitrary instant in time. If, say, the frequency  $f_0 = 2$  Hz, then the dot would rotate around the circle two times per second. We can also think of another complex number  $e^{-j2\pi f_0 t}$  (the white dot) orbiting in a clockwise direction because its phase angle gets more negative as time increases.

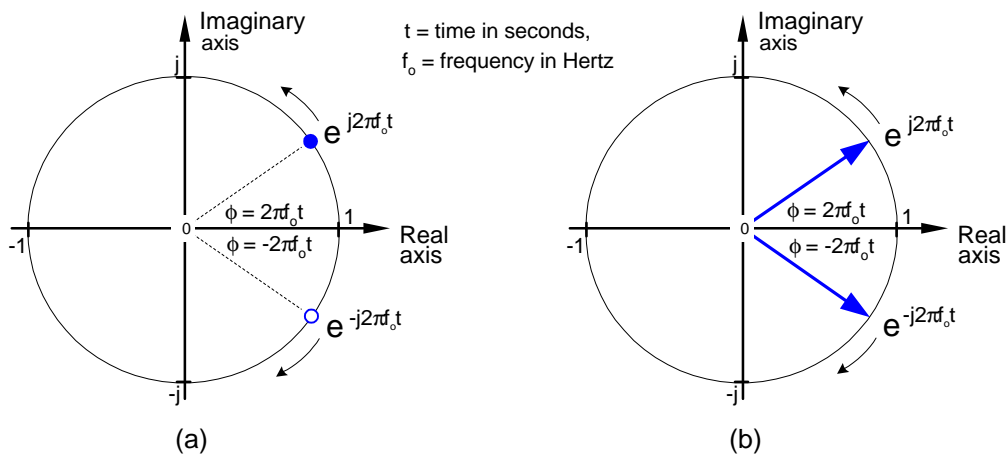
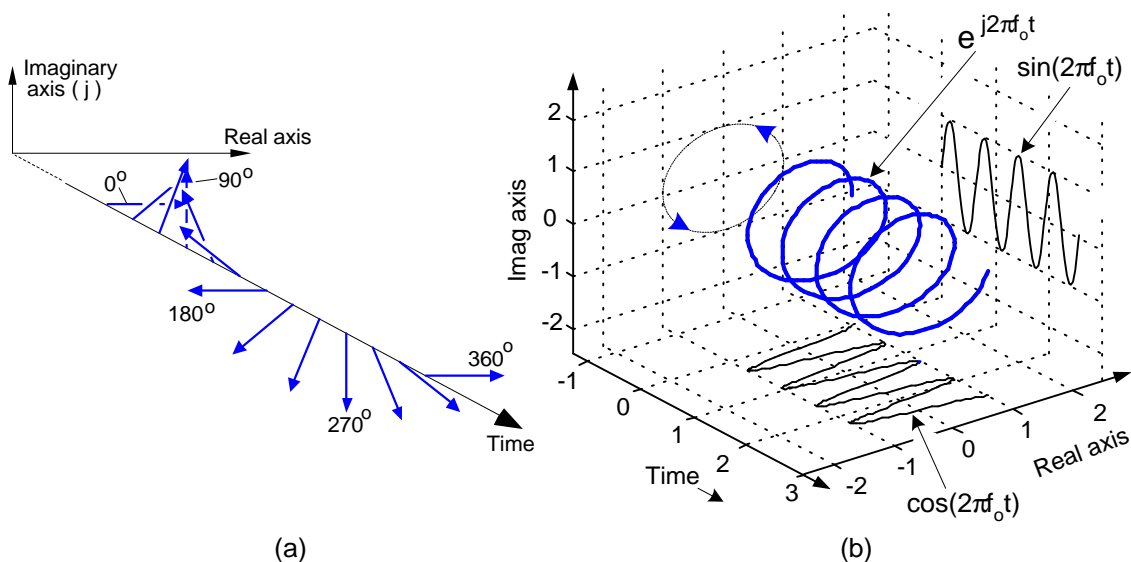

**Figure 5.** A snapshot, in time, of two complex numbers whose exponents change with time.

Let's now call our two  $e^{j2\pi f_0 t}$  and  $e^{-j2\pi f_0 t}$  complex expressions *quadrature signals*. They each have both real and imaginary parts, and they are both functions of time. Those  $e^{j2\pi f_0 t}$  and  $e^{-j2\pi f_0 t}$  expressions are often called *complex exponentials* in the literature.

We can also think of those two quadrature signals,  $e^{j2\pi f_0 t}$  and  $e^{-j2\pi f_0 t}$ , as the tips of two phasors rotating in opposite directions as shown in Figure 5(b). We're going to stick with this phasor notation for now because it'll allow us to achieve our goal of representing real sinusoids in the context of the complex plane. Don't touch that dial!

To ensure that we understand the behavior of those phasors, Figure 6(a) shows the three-dimensional path of the  $e^{j2\pi f_0 t}$  phasor as time passes. We've added the time axis, coming out of the page, to show the spiral path of the phasor. Figure 6(b) shows a continuous version of just the tip of the  $e^{j2\pi f_0 t}$  phasor. That  $e^{j2\pi f_0 t}$  complex number, or if you wish, the phasor's tip, follows a corkscrew path spiraling along, and centered about, the time axis. The real and imaginary parts of  $e^{j2\pi f_0 t}$  are shown as the sine and cosine projections in Figure 6(b).



**Figure 6.** The motion of the  $e^{j2\pi f_0 t}$  phasor (a), and phasor's tip (b).

Return to Figure 5(b) and ask yourself: "Self, what's the vector sum of those two phasors as they rotate in opposite directions?" Think about this for a moment... That's right, the phasors' real parts will always add constructively, and their imaginary parts will always cancel. This means that the summation of these  $e^{j2\pi f_0 t}$  and  $e^{-j2\pi f_0 t}$  phasors will always be a purely real number. Implementations of modern-day digital communications systems are based on this property!

To emphasize the importance of the real sum of these two *complex sinusoids* we'll draw yet another picture. Consider the waveform in the three-dimensional Figure 7 generated by the sum of two half-magnitude complex phasors,  $e^{j2\pi f_0 t}/2$  and  $e^{-j2\pi f_0 t}/2$ , rotating in opposite directions about, and moving down along, the time axis.

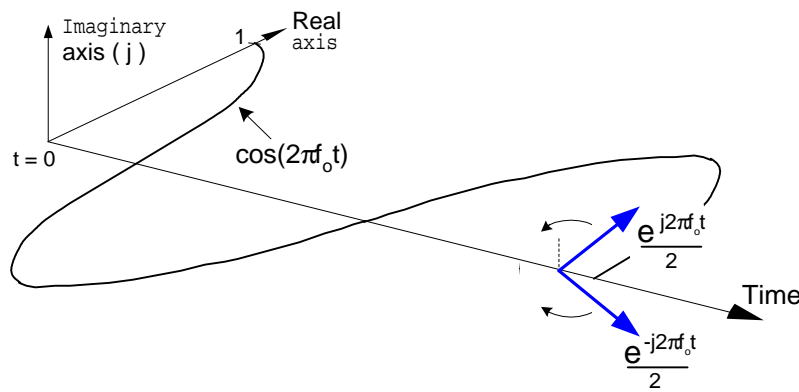

**Figure 7.** A cosine represented by the sum of two rotating complex phasors.

Thinking about these phasors, it's clear now why the cosine wave can be equated to the sum of two complex exponentials by

$$\cos(2\pi f_0 t) = \frac{e^{j2\pi f_0 t}}{2} + \frac{e^{-j2\pi f_0 t}}{2} = \frac{e^{j2\pi f_0 t} + e^{-j2\pi f_0 t}}{2} \quad (10)$$

Eq. (10), a well-known and important expression, is also called one of Euler's identities. We could have derived this identity by solving Eqs. (7) and (8) for  $j\sin(\phi)$ , equating those two expressions, and solving that final equation for  $\cos(\phi)$ . Similarly, we could go through that same algebra exercise and show that a real sinewave is also the sum of two complex exponentials as

$$\sin(2\pi f_0 t) = \frac{e^{j2\pi f_0 t} - e^{-j2\pi f_0 t}}{2j} = j \frac{e^{-j2\pi f_0 t} - e^{j2\pi f_0 t}}{2} \quad (11)$$

Look at Eqs. (10) and (11) carefully—they are the standard expressions for a cosine wave and a sinewave, using complex notation, seen throughout the literature of quadrature communications systems. To keep the reader's mind from spinning like those complex phasors, please realize that the sole purpose of Figures 5 through 7 is to validate the complex expressions of the cosine and sinewave given in Eqs. (10) and (11). Those two equations, along with Eqs. (7) and (8), are the Rosetta Stone of quadrature signal processing. We can now easily translate, back and forth, between real sinusoids and complex exponentials.

Let's step back now and remind ourselves what we're doing. We are learning how real signals, that can be transmitted down a coax cable or digitized and stored in a computer's memory, can be represented in complex number notation. Yes, the constituent parts of a complex number are each real, but we're treating those parts in a special way—we're treating them in *quadrature*.

## **Representing Quadrature Signals In the Frequency Domain**

Now that we know much about the time-domain nature of quadrature signals, we're ready to look at their frequency-domain descriptions. This material will be easy for you to understand because we'll illustrate the full three-dimensional aspects of the frequency domain. That way

none of the phase relationships of our quadrature signals will be hidden from view. Figure 8 tells us the rules for representing complex exponentials in the frequency domain.

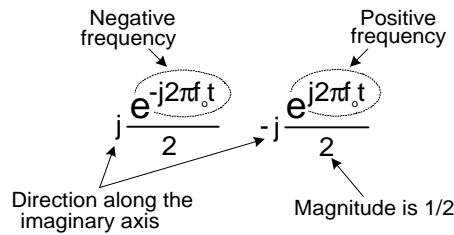

**Figure 8.** Interpretation of complex exponentials.

We'll represent a single complex exponential as a narrowband impulse located at the frequency specified in the exponent. In addition, we'll show the phase relationships between those complex exponentials along the real and imaginary axes. To illustrate those phase relationships, a complex frequency domain representation is necessary. With all that said, take a look at Figure 9.

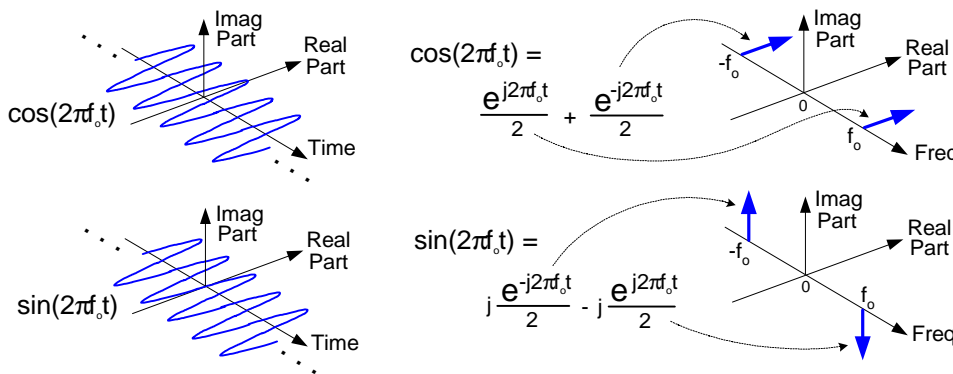

**Figure 9.** Complex frequency domain representation of a cosine wave and sinewave.

See how a real cosine wave and a real sinewave are depicted in our complex frequency domain representation on the right side of Figure 9. Those bold arrows on the right of Figure 9 are not rotating phasors, but instead are frequency-domain impulse symbols indicating a single spectral line for single a complex exponential  $e^{j2\pi f_0 t}$ . The directions in which the spectral impulses are pointing merely indicate the relative phases of the spectral components. The amplitude of those spectral impulses are 1/2. OK ... why are we bothering with this 3-D frequency-domain representation? Because it's the tool we'll use to understand the generation (modulation) and detection (demodulation) of quadrature signals in digital (and some analog) communications systems, and that's one of the goals of this tutorial. Before we go there however, let's validate this frequency-domain representation with a little example.

Figure 10 is a straightforward example of how we use the complex frequency domain. There we begin with a real sinewave, multiply it by  $j$ , and then add it to a real cosine wave of the same frequency. The result is the single complex exponential  $e^{j2\pi f_0 t}$  illustrating graphically Euler's identity that we stated mathematically in Eq. (7).

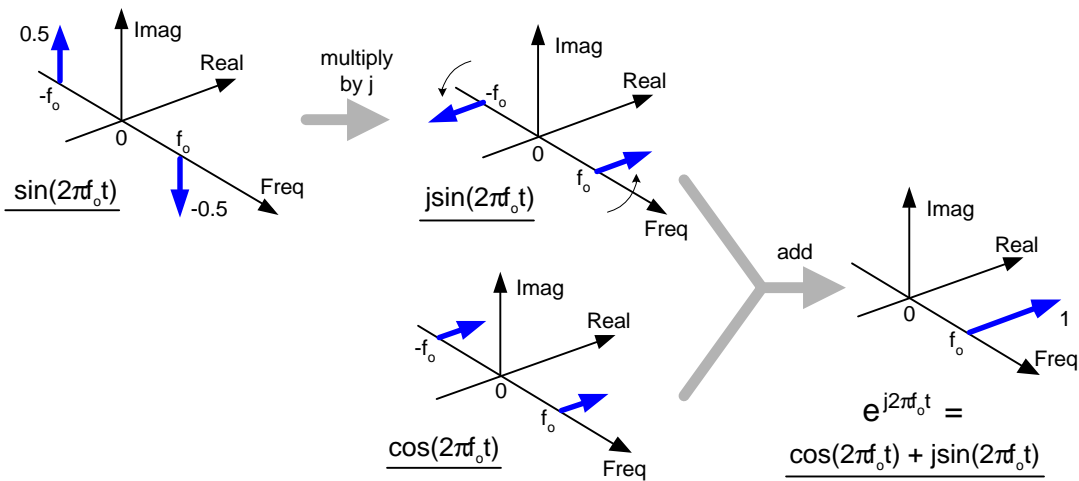

**Figure 10.** Complex frequency-domain view of Euler's:  $e^{j2\pi f_0 t} = \cos(2\pi f_0 t) + j\sin(2\pi f_0 t)$ .

On the frequency axis, the notion of negative frequency is seen as those spectral impulses located at  $-2\pi f_0$  radians/sec on the frequency axis. This figure shows the big payoff: *When we use complex notation, generic complex exponentials like  $e^{j2\pi f t}$  and  $e^{-j2\pi f t}$  are the fundamental constituents of the real sinusoids  $\sin(2\pi f t)$  or  $\cos(2\pi f t)$ .* That's because both  $\sin(2\pi f t)$  and  $\cos(2\pi f t)$  are made up of  $e^{j2\pi f t}$  and  $e^{-j2\pi f t}$  components. If you were to take the discrete Fourier transform (DFT) of discrete time-domain samples of a  $\sin(2\pi f_0 t)$  sinewave, a  $\cos(2\pi f_0 t)$  cosine wave, or a  $e^{j2\pi f_0 t}$  complex sinusoid and plot the complex results, you'd get exactly those narrowband impulses in Figure 10.

If you understand the notation and operations in Figure 10, pat yourself on the back because you know a great deal about nature and mathematics of quadrature signals.

### **Bandpass Quadrature Signals In the Frequency Domain**

In quadrature processing, by convention, the real part of the spectrum is called the *in-phase* component and the imaginary part of the spectrum is called the *quadrature* component. The signals whose complex spectra are in Figure 11(a), (b), and (c) are real, and in the time domain they can be represented by amplitude values that have nonzero real parts and zero-valued imaginary parts. We're not forced to use complex notation to represent them in the time domain—the signals are real.

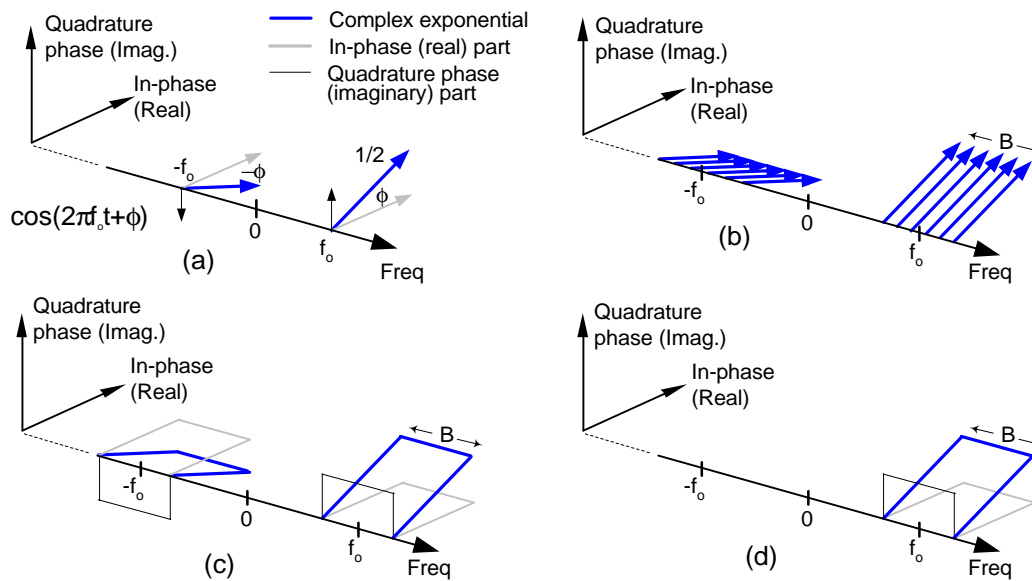
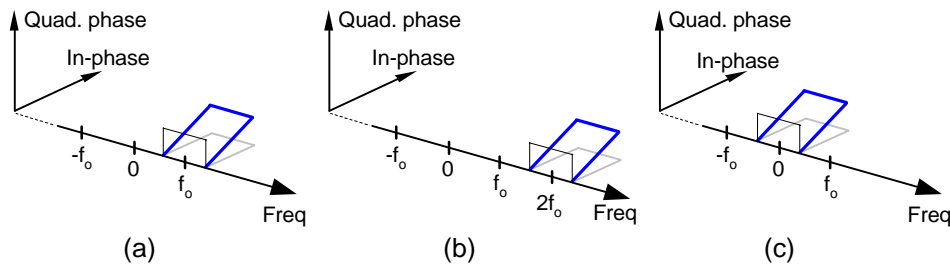

**Figure 11.** Quadrature representation of signals: (a) Real sinusoid  $\cos(2\pi f_0 t + \phi)$ , (b) Real bandpass signal containing seven sinusoids over bandwidth  $B$ ; (c) Real bandpass signal containing an infinite number of sinusoids over bandwidth  $B$  Hz; (d) Complex bandpass signal of bandwidth  $B$  Hz.

Real signals always have positive and negative frequency spectral components. For any real signal, the positive and negative frequency components of its in-phase (real) spectrum always have even symmetry around the zero-frequency point. That is, the in-phase part's positive and negative frequency components are mirror images of each other. Conversely, the positive and negative frequency components of its quadrature (imaginary) spectrum are always negatives of each other. This means that the phase angle of any given positive quadrature frequency component is the negative of the phase angle of the corresponding quadrature negative frequency component as shown by the thin solid arrows in Figure 11(a). This 'conjugate symmetry' is the invariant nature of real signals when their spectra are represented using complex notation.

Let's remind ourselves again, those bold arrows in Figure 11(a) and (b) are not rotating phasors. They're frequency-domain impulse symbols indicating a single complex exponential  $e^{j2\pi f t}$ . The directions in which the impulses are pointing show the relative phases of the spectral components.

There's an important principle to keep in mind before we continue. Multiplying a time signal by the complex exponential  $e^{j2\pi f_0 t}$ , what we can call *quadrature mixing* (also called *complex mixing*), shifts that signal's spectrum upward in frequency by  $f_0$  Hz as shown in Figure 12 (a) and (b). Likewise, multiplying a time signal by  $e^{-j2\pi f_0 t}$  shifts that signal's spectrum down in frequency by  $f_0$  Hz.



**Figure 12.** Quadrature mixing of a signal: (a) Spectrum of a complex signal  $x(t)$ , (b) Spectrum of  $x(t)e^{j2\pi f_0 t}$ , (c) Spectrum of  $x(t)e^{-j2\pi f_0 t}$ .

## A Quadrature-Sampling Example

We can use all that we've learned so far about quadrature signals by exploring the process of *quadrature-sampling*. Quadrature-sampling is the process of digitizing a continuous (analog) bandpass signal and translating its spectrum to be centered at zero Hz. Let's see how this popular process works by thinking of a continuous bandpass signal, of bandwidth  $B$ , centered about a carrier frequency of  $f_c$  Hz.

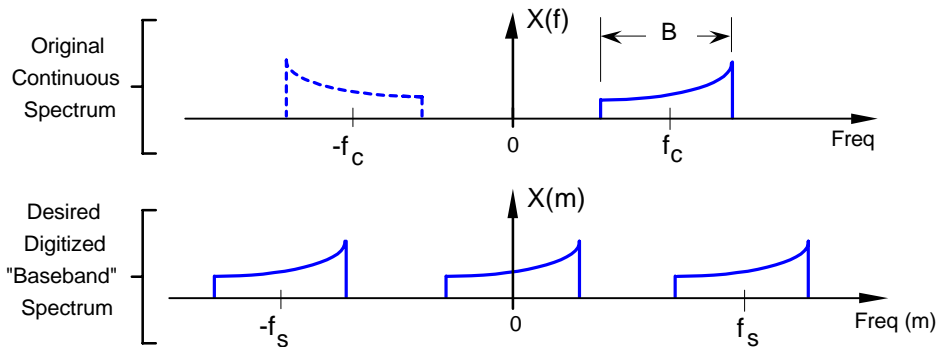

**Figure 13.** The 'before and after' spectra of a quadrature-sampled signal.

Our goal in quadrature-sampling is to obtain a digitized version of the analog bandpass signal, but we want that digitized signal's discrete spectrum centered about zero Hz, not  $f_c$  Hz. That is, we want to mix a time signal with  $e^{-j2\pi f_c t}$  to perform complex downconversion. The frequency  $f_s$  is the digitizer's sampling rate in samples/second. We show replicated spectra at the bottom of Figure 13 just to remind ourselves of this effect when A/D conversion takes place.

OK, ... take a look at the following quadrature-sampling block diagram known as I/Q demodulation (or 'Weaver demodulation' for those folk with experience in communications theory) shown at the top of Figure 14. That arrangement of two sinusoidal oscillators, with their relative  $90^\circ$  phase, is often called a 'quadrature-oscillator'.

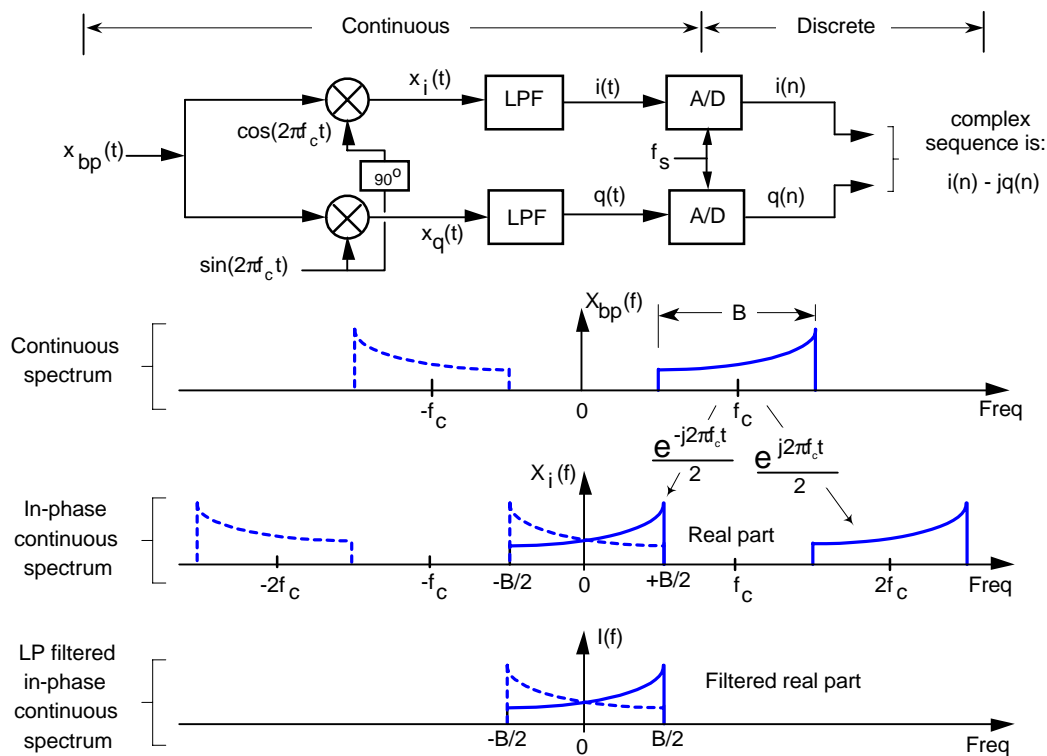

**Figure 14.** Quadrature-sampling block diagram and spectra within the in-phase (upper) signal path.

Those  $e^{j2\pi f_c t}$  and  $e^{-j2\pi f_c t}$  terms in that busy Figure 14 remind us that the constituent complex exponentials comprising a real cosine duplicates each part of  $X_{bp}(f)$  spectrum to produce the  $X_i(f)$  spectrum. The Figure shows how we get the filtered continuous in-phase portion of our desired complex quadrature signal. By definition, those  $X_i(f)$  and  $I(f)$  spectra are treated as 'real only'.

Likewise, Figure 15 shows how we get the filtered continuous quadrature phase portion of our complex quadrature signal by mixing  $x_{bp}(t)$  with  $\sin(2\pi f_c t)$ .

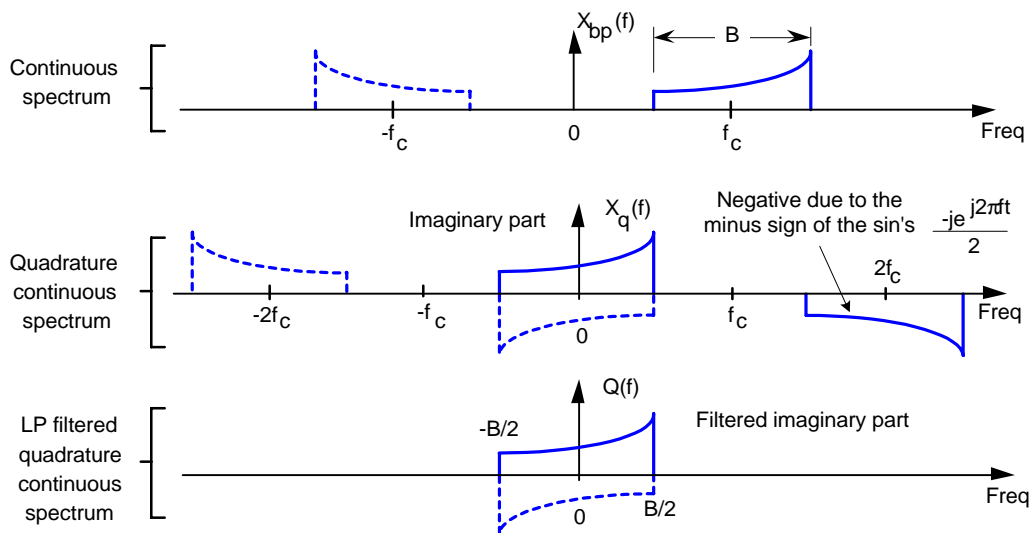

**Figure 15.** Spectra within the quadrature phase (lower) signal path of the block diagram.

Here's where we're going:  $I(f) - jQ(f)$  is the spectrum of a complex replica of our original bandpass signal  $x_{bp}(t)$ . We show the addition of those two spectra in Figure 16.

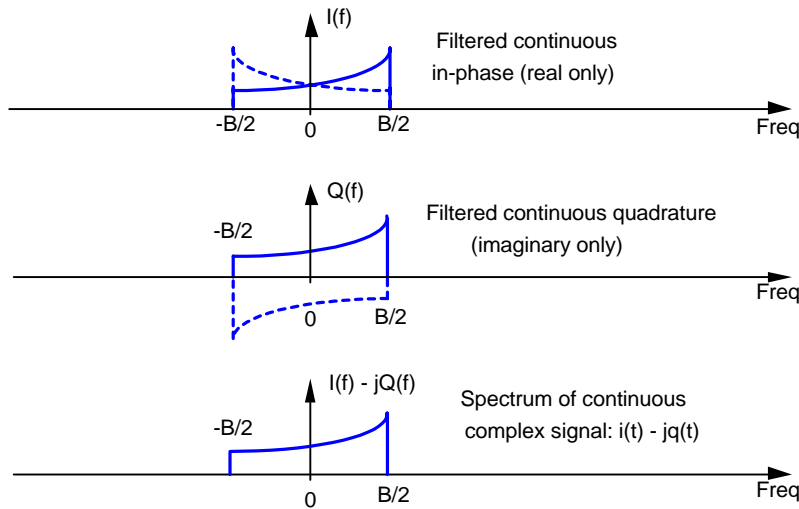

**Figure 16.** Combining the  $I(f)$  and  $Q(f)$  spectra to obtain the desired ' $I(f) - jQ(f)$ ' spectra.

This typical depiction of quadrature-sampling seems like mumbo jumbo until you look at this situation from a three-dimensional standpoint, as in Figure 17, where the  $-j$  factor rotates the 'imaginary-only'  $Q(f)$  by  $-90^\circ$ , making it 'real-only'. This  $-jQ(f)$  is then added to  $I(f)$ .

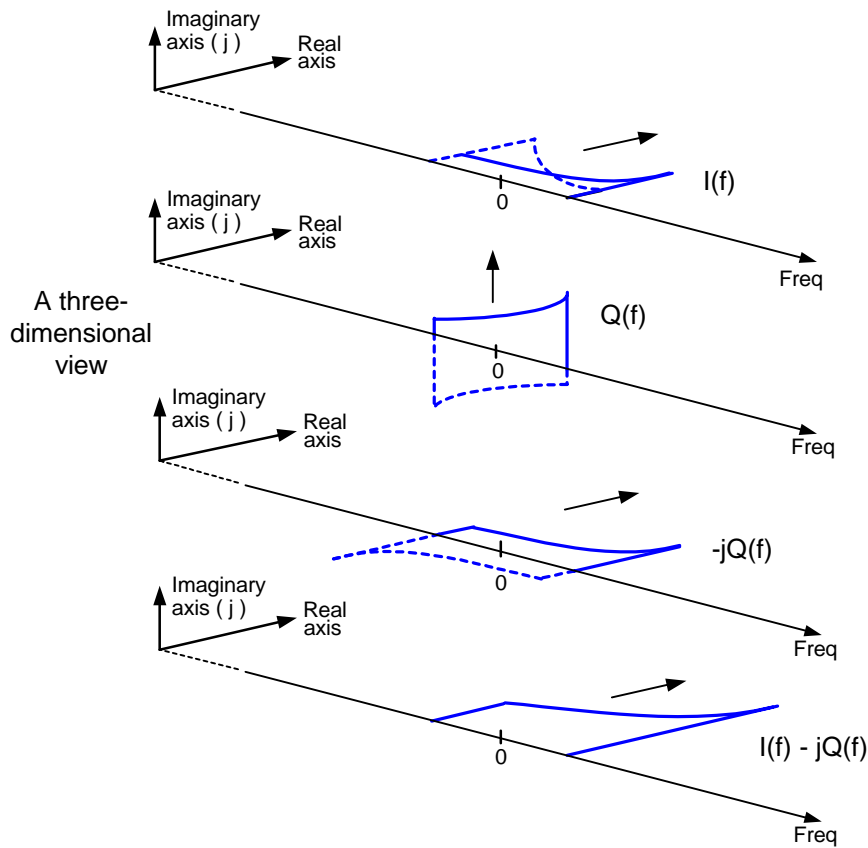

**Figure 17.** 3-D view of combining the  $I(f)$  and  $Q(f)$  spectra to obtain the  $I(f) - jQ(f)$  spectra.

The complex spectrum at the bottom Figure 18 shows what we wanted; a digitized version of the complex bandpass signal centered about zero Hz.

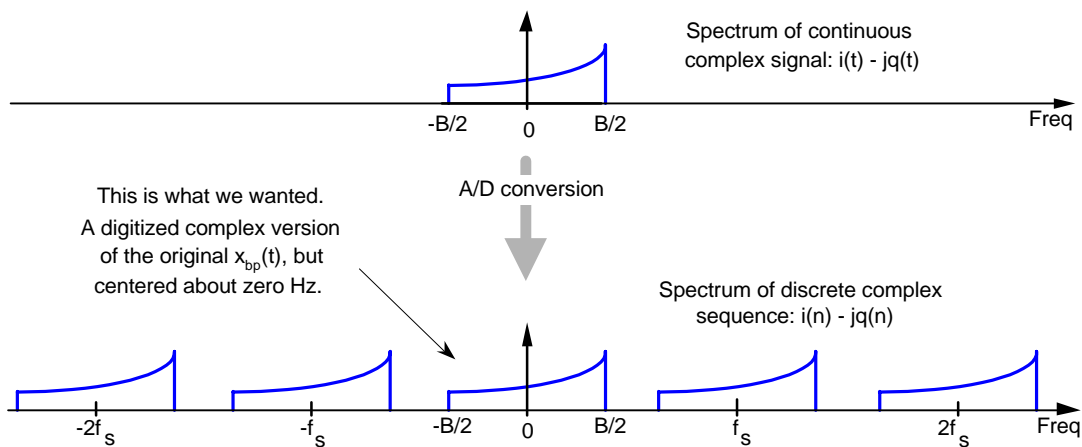

**Figure 18.** The continuous complex signal  $i(t) - jq(t)$  is digitized to obtain discrete  $i(n) - jq(n)$ .

Some advantages of this quadrature-sampling scheme are:

- Each A/D converter operates at half the sampling rate of standard real-signal sampling,
- In many hardware implementations operating at lower clock rates save power.

- For a given  $f_s$  sampling rate, we can capture wider-band analog signals.
- Quadrature sequences make FFT processing more efficient due to a wider frequency range coverage.
- Because quadrature sequences are effectively oversampled by a factor of two, signal squaring operations are possible without the need for upsampling.
- Knowing the phase of signals enables coherent processing, and
- Quadrature-sampling also makes it easier to measure the instantaneous magnitude and phase of a signal during demodulation.

Returning to the block diagram reminds us of an important characteristic of quadrature signals. We can send an analog quadrature signal to a remote location; to do so we use two coax cables on which the two real  $i(t)$  and  $q(t)$  signals travel. (To transmit a discrete time-domain quadrature sequence, we'd need two multi-conductor ribbon cables as indicated by Figure 19.)

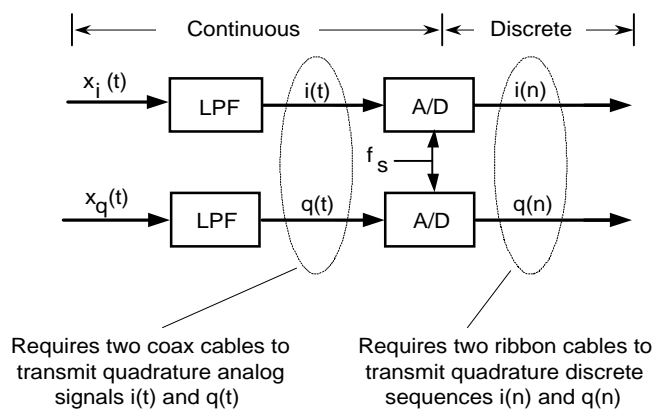

**Figure 19.** Reiteration of how quadrature signals comprise two real parts.

To appreciate the physical meaning of our discussion here, let's remember that a continuous quadrature signal  $x_c(t) = i(t) + jq(t)$  is not just a mathematical abstraction. We can generate  $x_c(t)$  in our laboratory and transmit it to the lab down the hall. All we need is two sinusoidal signal generators, set to the same frequency  $f_0$ . (However, somehow we have to synchronize those two hardware generators so that their relative phase shift is fixed at  $90^\circ$ .) Next we connect coax cables to the generators' output connectors and run those two cables, labeled ' $i(t)$ ' for our cosine signal and ' $q(t)$ ' for our sinewave signal, down the hall to their destination

Now for a two-question pop quiz. In the other lab, what would we see on the screen of an oscilloscope if the continuous  $i(t)$  and  $q(t)$  signals were connected to the horizontal and vertical input channels, respectively, of the scope? (Remembering, of course, to set the scope's Horizontal Sweep control to the 'External' position.)

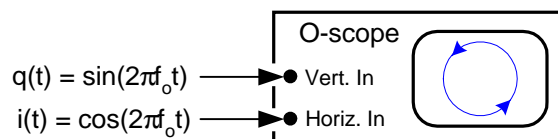

**Figure 20.** Displaying a quadrature signal using an oscilloscope.

Next, what would be seen on the scope's display if the cables were mislabeled and the two signals were inadvertently swapped?

The answer to the first question is that we'd see a bright 'spot' rotating counterclockwise in a circle on the scope's display. If the cables were swapped, we'd see another circle, but this time it would be orbiting in a clockwise direction. This would be a neat little demonstration if we set the signal generators'  $f_0$  frequencies to, say, 1 Hz.

This oscilloscope example helps us answer the important question, "When we work with quadrature signals, how is the  $j$ -operator implemented in hardware?" The answer is that the  $j$ -operator is implemented by how we treat the two signals relative to each other. We have to treat them *orthogonally* such that the in-phase  $i(t)$  signal represents an East-West value, and the quadrature phase  $q(t)$  signal represents an orthogonal North-South value. (By orthogonal, I mean that the North-South direction is oriented exactly  $90^\circ$  relative to the East-West direction.) So in our oscilloscope example the  $j$ -operator is implemented merely by how the connections are made to the scope. The in-phase  $i(t)$  signal controls horizontal deflection and the quadrature phase  $q(t)$  signal controls vertical deflection. The result is a two-dimensional quadrature signal represented by the instantaneous position of the dot on the scope's display.

The person in the lab down the hall who's receiving, say, the discrete sequences  $i(n)$  and  $q(n)$  has the ability to control the orientation of the final complex spectra by adding or subtracting the  $jq(n)$  sequence as shown in Figure 21.

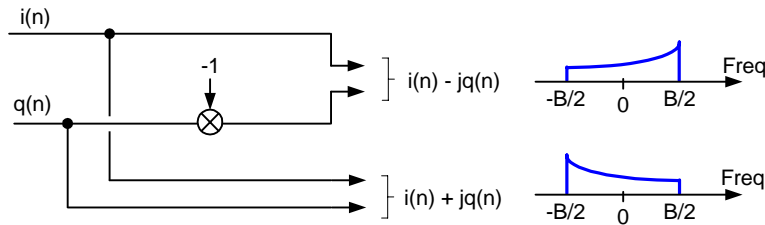

**Figure 21.** Using the sign of  $q(n)$  to control spectral orientation.

The top path in Figure 21 is equivalent to multiplying the original  $x_{bp}(t)$  by  $e^{-j2\pi f_c t}$ , and the bottom path is equivalent to multiplying the  $x_{bp}(t)$  by  $e^{j2\pi f_c t}$ . Therefore, had the quadrature portion of our quadrature-oscillator at the top of Figure 14 been negative,  $-\sin(2\pi f_c t)$ , the resultant complex spectra would be flipped (about 0 Hz) from those spectra shown in Figure 21.

While we're thinking about flipping complex spectra, let's remind ourselves that there are two simple ways to reverse (invert) an  $x(n) = i(n) + jq(n)$  sequence's spectral magnitude. As shown in Figure 21, we can perform conjugation to obtain an  $x'(n) = i(n) - jq(n)$  with an inverted magnitude spectrum. The second method is to swap  $x(n)$ 's individual  $i(n)$  and  $q(n)$  sample values to create a new sequence  $y(n) = q(n) + ji(n)$  whose spectral magnitude is inverted from  $x(n)$ 's spectral magnitude. (Note, while  $x'(n)$ 's and  $y(n)$ 's spectral magnitudes are equal, their spectral phases are not equal.)

## Conclusions

This ends our little quadrature signals tutorial. We learned that using the complex plane to

visualize the mathematical descriptions of complex numbers enabled us to see how quadrature and real signals are related. We saw how three-dimensional frequency-domain depictions help us understand how quadrature signals are generated, translated in frequency, combined, and separated. Finally we reviewed an example of quadrature-sampling and two schemes for inverting the spectrum of a quadrature sequence.



## **References**

- [1] D. Struik, *A Concise History of Mathematics*, Dover Publications, NY, 1967.
- [2] D. Bergamini, *Mathematics*, Life Science Library, Time Inc., New York, 1963.
- [3] N. Boutin, "Complex Signals," *RF Design*, December 1989.

Answer to trivia question just following Eq. (5) is: The scarecrow in Wizard of Oz. Also, I say Thanks to Grant Griffin whose suggestions improved the value of this tutorial.

## **Have you heard this little story?**

While in Berlin, Leonhard Euler was often involved in philosophical debates, especially with Voltaire. Unfortunately, Euler's philosophical ability was limited and he often blundered to the amusement of all involved. However, when he returned to Russia, he got his revenge. Catherine the Great had invited to her court the famous French philosopher Diderot, who to the chagrin of the czarina, attempted to convert her subjects to atheism. She asked Euler to quiet him. One day in the court, the French philosopher, who had no mathematical knowledge, was informed that someone had a mathematical proof of the existence of God. He asked to hear it. Euler then stepped forward and stated:

"Sir,  $\frac{a + b^n}{n} = x$ , hence God exists; reply!" Diderot had no idea what Euler was talking about. However, he did understand the chorus of laughter that followed and soon after returned to France.

(Above paragraph was found on a terrific website detailing the history of mathematics and mathematicians:  
[http://www.shu.edu/academic/arts\\_sci/Undergraduate/math\\_cs/sites/math/realms/history/euler.html](http://www.shu.edu/academic/arts_sci/Undergraduate/math_cs/sites/math/realms/history/euler.html))

Although it's a cute story, serious math historians don't believe it. They know that Diderot did have some mathematical knowledge and they just can't imagine Euler clowning around in that way.